

»R-SV2« series, 2-stage

High quality, robust and long lifetime one-hand rotation secure coupling.

A secure connection is made by pushing in the plug-in nipple that clicks in audibly. Uncoupling is done by rotating the sleeve anti-clockwise. For this, the pending pressure in the coupling and line are vented, however the plug-in nipple is not completely released via a safety latch. The plug-in nipple can only be pulled out after a clockwise rotation of the sleeve.

This coupling meets ISO standard DIN EN ISO 4414, EN 983.

These safety couplings are not suitable for direct attachment to pulsating tools.

We recommend using our vibration dampers, according to ISO 6150 § 7.1.

Areas of application: Pneumatic system, machine and plant engineering, measurement, monitoring and control systems, manufacturing industry, workshops, automotive.

Operating pressure	max. 25 bar / max. 16 bar when attaching / detaching
Temperature range	-20 °C to 100 °C
Flow rate	1200 l/min (air)
Flow rate measurement	at 6 bar and $\Delta p = 0.5$ bar
Medium	Compressed air, gases
Housing	Steel, QPQ treated
Valve	Brass with a bare metal surface
Spring	Stainless steel
Sleeve	Polyamide, red
Threaded piece	Galvanised steel
Sealant	NBR
Lubrication	Containing silicone
Corrosion resistance	72 h salt spray test according to DIN 50021 SS
Plug profile	acc. ISO 6150 C



Swivel safety coupling DN 8, acc. ISO 6150 C, male

Art. No.	Type No.	Connection	Length mm	a/f mm
141759	425.12-DREH	G 3/8 ET	78.0	27
141760	425.13-DREH	G 1/2 ET	78.0	27

Swivel safety coupling DN 8, acc. ISO 6150 C, female

Art. No.	Type No.	Connection	Length mm	a/f mm
141756	425.01-DREH	G 1/4 IT	81.0	27
141757	425.02-DREH	G 3/8 IT	81.0	27
141758	425.03-DREH	G 1/2 IT	81.0	27

Swivel safety coupling DN 8, acc. ISO 6150 C, with hose stem

Art. No.	Type No.	Connection	Length mm	a/f mm
141761	425.22-DREH	Stem, I.D. 8	89.0	27
141762	425.24-DREH	Stem, I.D. 10	90.0	27
141763	425.25-DREH	Stem, I.D. 13	90.0	27

P 5-133 e

**Swivel safety couplings DN 8,
acc. ISO 6150 C**
Art. No. 141759 to 141772

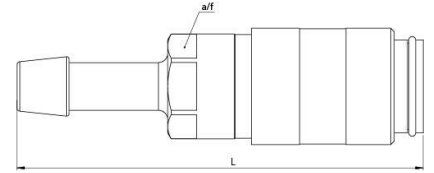
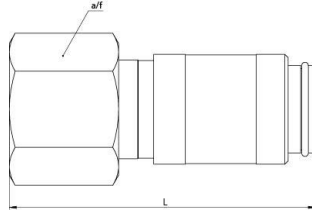
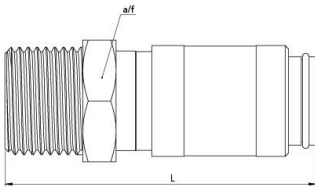

425.12-DREH



425.02-DREH



425.24-DREH

Stem for couplings DN 8, ISO 6150 C, steel, QPQ treated

Art. No.	Type No.	Description	Length mm
141704	425.72	Stem, I.D. 8	63.0
141705	425.74	Stem, I.D. 10	63.0
141706	425.75	Stem, I.D. 13	63.0
141707	425.76	Stem, I.D. 16	63.0

Plug for couplings DN 8, ISO 6150 C, steel, QPQ treated, male

Art. No.	Type No.	Description	Length mm	a/f mm
141696	425.61	Plug, G 1/4 ET	56.0	17
141697	425.62	Plug, G 3/8 ET	56.0	19
141698	425.61-NTP	Plug, NTP 1/4 ET	59.0	17
141699	425.62-NTP	Plug, NTP 3/8 ET	59.0	19

Plug for couplings DN 8, ISO 6150 C, steel, QPQ treated, female

Art. No.	Type No.	Description	Length mm	a/f mm
141700	425.51	Plug, G 1/4 IT	56.0	17
141701	425.52	Plug, G 3/8 IT	58.0	24
141702	425.51-NPT	Plug, NPT 1/4 IT	57.0	17
141703	425.52-NPT	Plug, NPT 3/8 IT	58.0	24

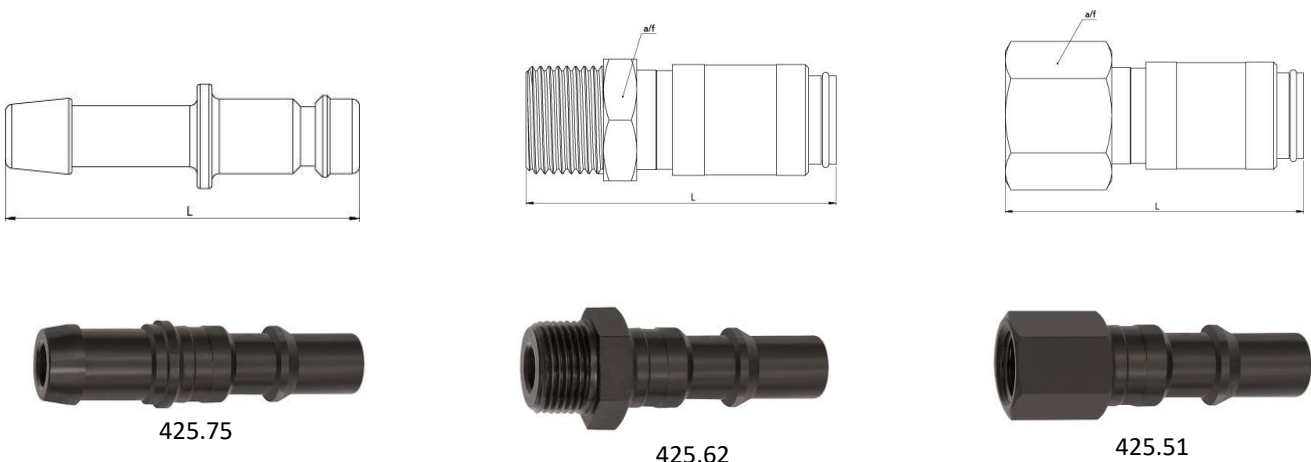

Stem with check valve for couplings DN 8, ISO 6150 C, hardened, galvanised steel, steel, QPQ treated

Art. No.	Type No.	Description	Length mm
141774	425.74-RSV	Stem, I.D. 10	91.0
141775	425.75-RSV	Stem, I.D. 13	92.0

Plug with check valve for couplings DN 8, ISO 6150 C, hardened, galvanised steel, steel, QPQ treated, male

Art. No.	Type No.	Description	Length mm	a/f mm
141773	425.62-RSV	Plug, G 3/8 ET	79.0	19

Plug with check valve for couplings DN 8, ISO 6150 C, hardened, galvanised steel, steel, QPQ treated, female

Art. No.	Type No.	Description	Length mm	a/f mm
141772	425.52-RSV	Plug, G 3/8 IT	81.0	22

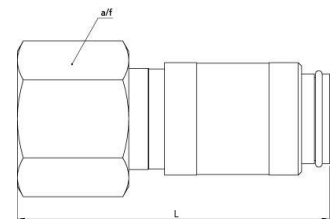
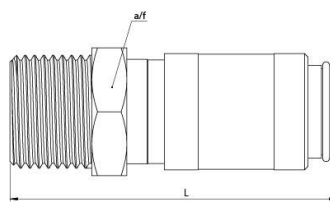
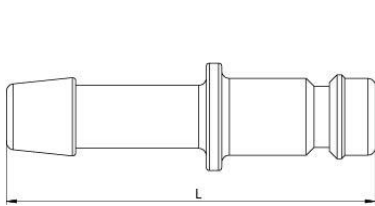

425.75-RSV



425.62-RSV



425.52-RSV

Installation location

The installation location of the quick-connect coupling must be selected so that the health of the person operating it cannot be harmed by sources of danger in the immediate surroundings, e.g. from slipping, jamming, contaminating or burning.

Low pressure applications

Threads for low-pressure applications are, if series-related no corresponding coatings or sealing rings are present, to be provided with suitable sealing materials, such as a PTFE belt or liquid sealing agent. Here the resistance to the flowing medium must be paid attention to.

Service manual

Quick-connect couplings are predominantly maintenance-free, if used in standard applications and handled carefully. The selection of the quick-connect coupling must be compatible with the intended purpose of use and material. Depending on the operating conditions it is recommended to provide the following points during maintenance:

External visual inspection with dirt in the functioning area of coupling and plug (seal area, control elements) these must be cleaned. The following distinguishing symptoms require replacement of the corresponding parts: Torn, damaged, heavily damaged or corroded parts, leaks on coupling and / or plug parts.

Function test under maximum Max. operating pressure can be used to test the quick-connect coupling for possible malfunctions and leaks. During the testing and operating phase it must be ensured that the operating personnel work protected.

Replacement intervals for quick-connect couplings must, if available, be adapted to the state or technical standards. However, also operating experiential values, which result from the required operational safety and the conditions of use, such as downtimes, coupling frequency, Max. operating pressure and properties of the medium, are critical for establishing the replacement intervals.

Pulsating tool

When using pulsating tools it is recommended to observe the standard ISO 6150, § 7.1. It recommends installing a minimum 300 mm long, flexible hose between the pulsating tool and the quick-connect coupling. The oscillating forces are taken by the hose piece and thus increase the service life of the quick-connect coupling. No warranty can be made for couplings mounted directly on pulsating tools.

Flow direction

The recommended flow direction is from the coupling to the plug if nothing else is specified in the technical data sheet.



Application with hoses

When using hoses the permissible Max. operating pressure and the working temperature must absolutely be observed and suitable hose connections must be seen to.